

4
Part Number

3
2
1
LSP-M19PA01-F-02 & LSP-M19PA01-M-02

M19PA01

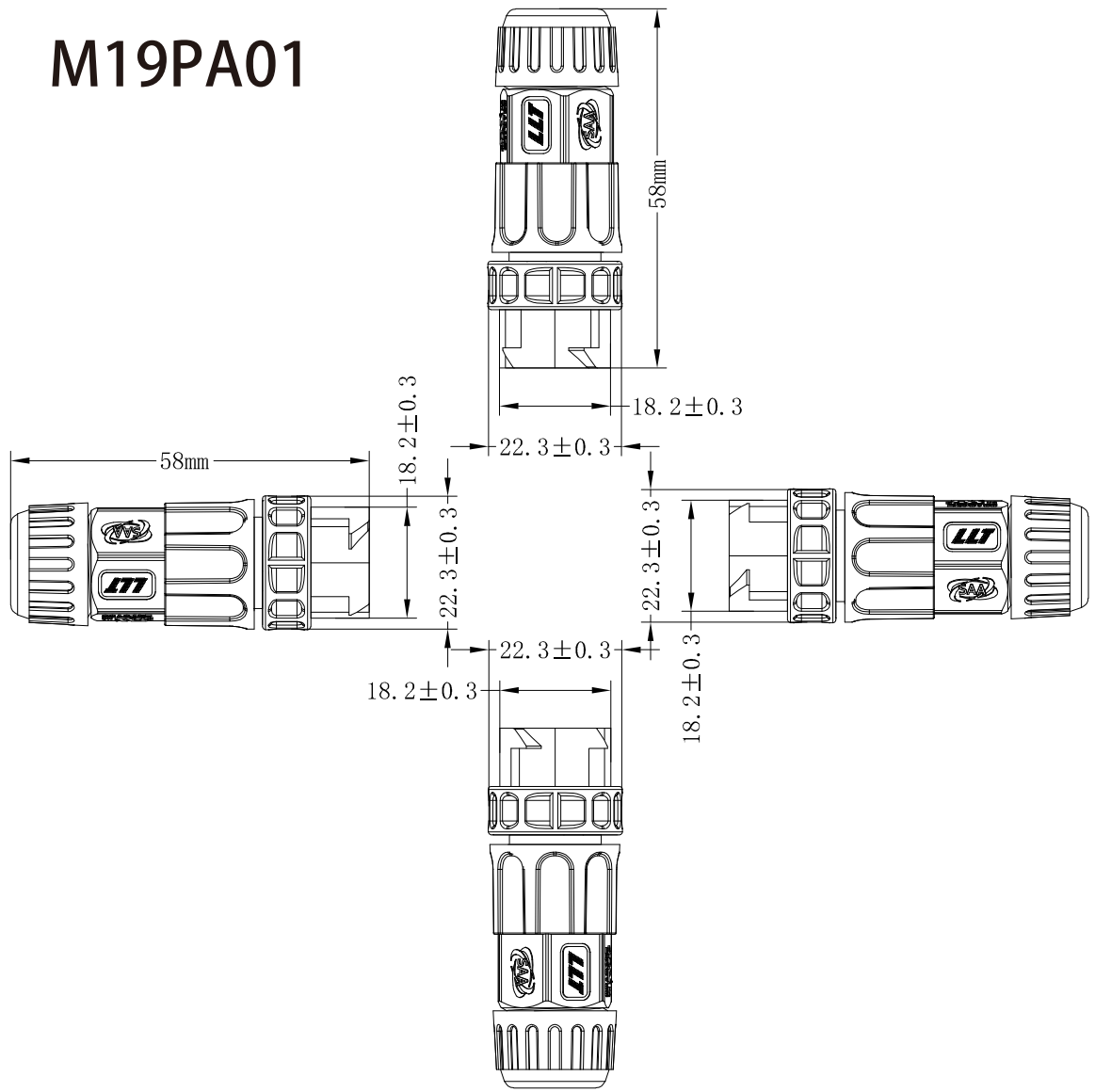

Pin 2
White
VDC (+)

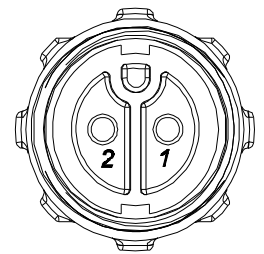

Pin 1
Black
VDC (-)

Female

Pin 1
Black
VDC (-)

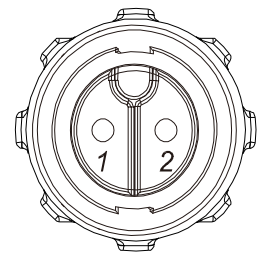

Pin 2
White
VDC (+)

Male

SEAPEARL TRADING LIMITED			
Part No.	LSP-M19PA01-F-02	LSP-M19PA01-M-02	
Model No.			
Description	Push lock Assembly type Female and Male	Ver.	
		Release Date	2018-7-27
Cable		Draw	曾镇辉
		APP'D	

4

3

2

1

Part Number

LSP-M19PA02-M-02 & LSP-M19PA02-F-02

M19PA02 w/Lock Ring

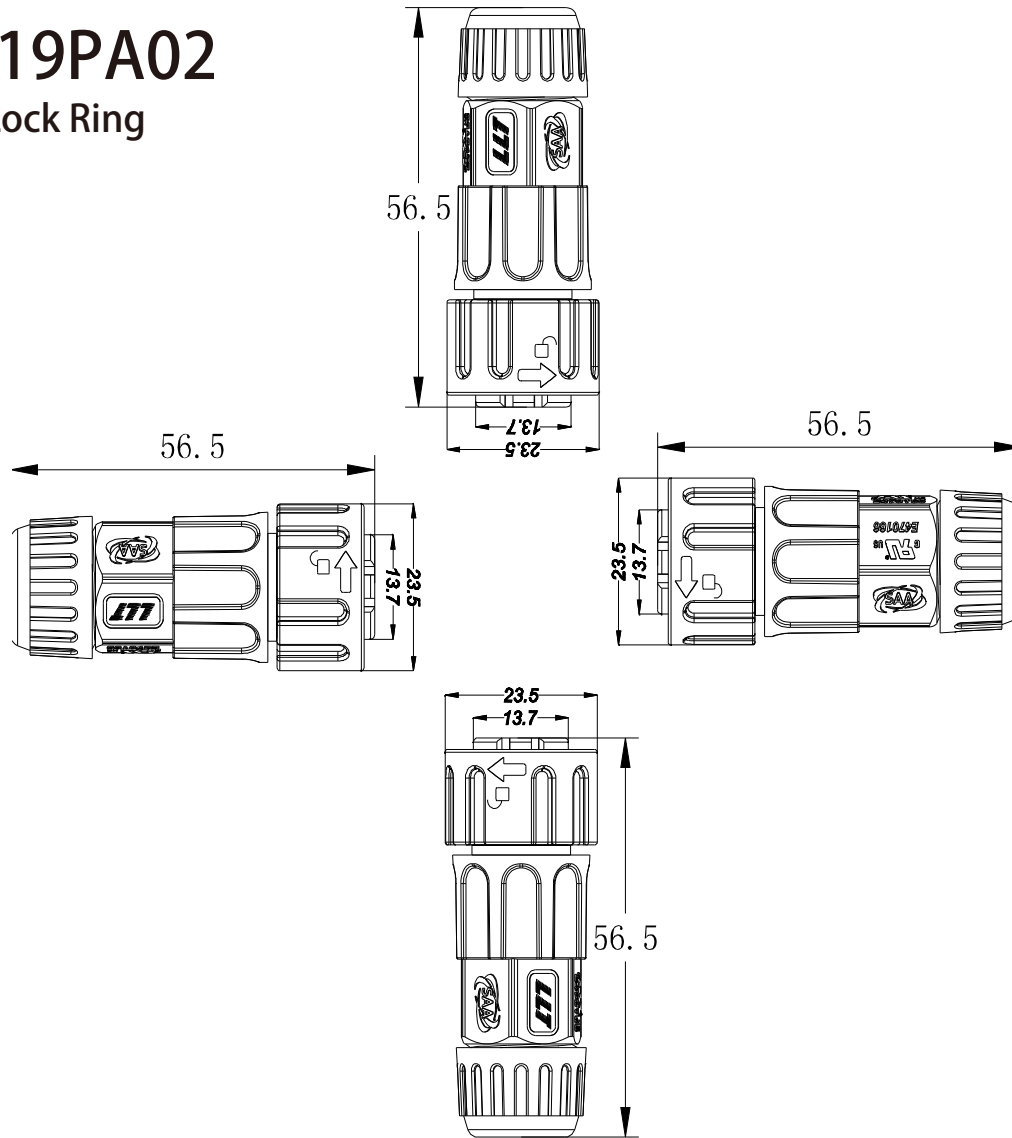

Pin 2
White
VDC (+)

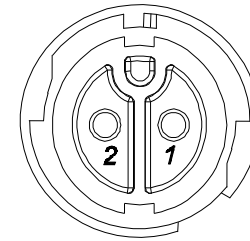

Pin 1
Black
VDC (-)

Female

Pin 1
Black
VDC (-)

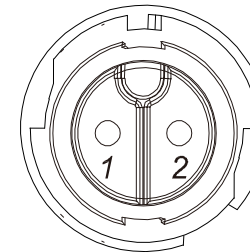

Pin 2
White
VDC (+)

Male

SEAPEARL TRADING LIMITED

Part No.	LSP-M19PA02-F-02	LSP-M19PA02-M-02	
Model No.			
Description	Push lock - Black Ring Assembly type Female and Male	Ver.	
		Release Date	2018-7-27
Cable		Draw	曾镇辉
		APP'D	

4
Part Number

3
2
1
LSP-M19PA01-F-03 & LSP-M19PA01-M-03

M19PA01

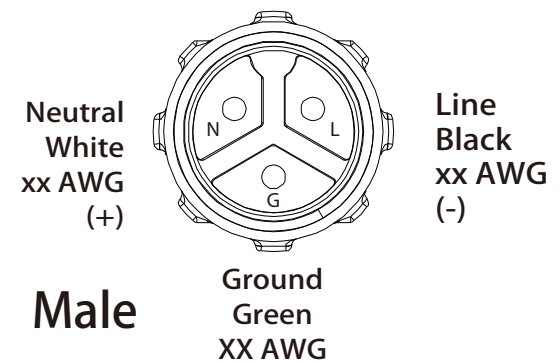
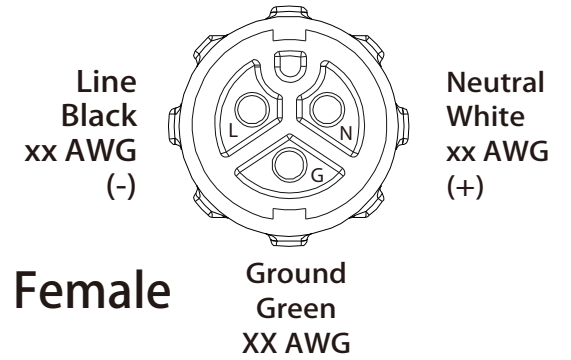
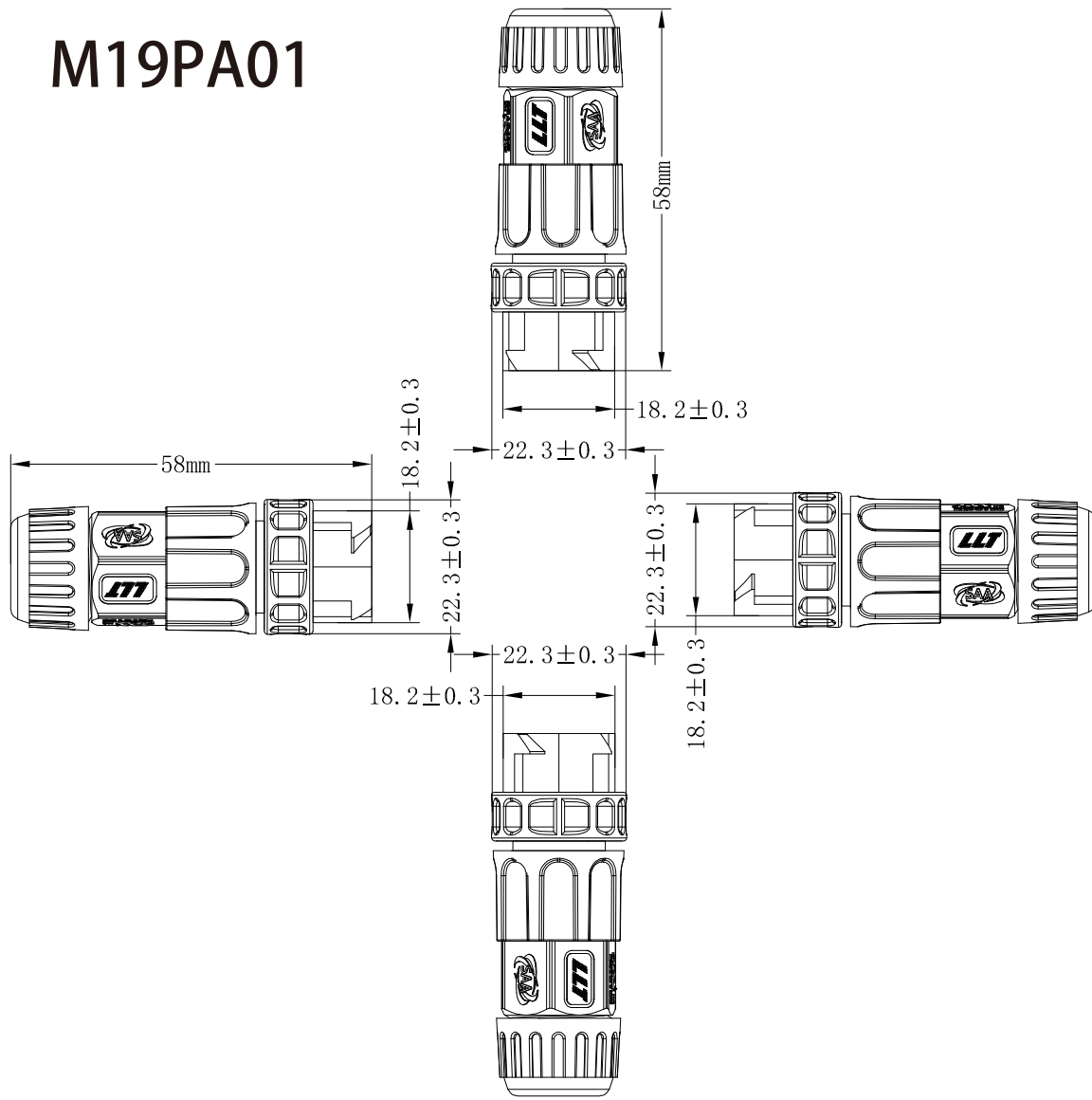

SEAPEARL TRADING LIMITED			
Part No.	LSP-M19PA01-F-03	LSP-M19PA01-M-03	
Model No.			
Description	Push lock Assembly type Female and Male	Ver.	
		Release Date	2018-7-27
Cable		Draw	曾镇辉
		APP'D	

4

3

2

1

4
Part Number

3
2
1
LSP-M19PA02-M-03 & LSP-M19PA02-F-03

M19PA02
w/Lock Ring

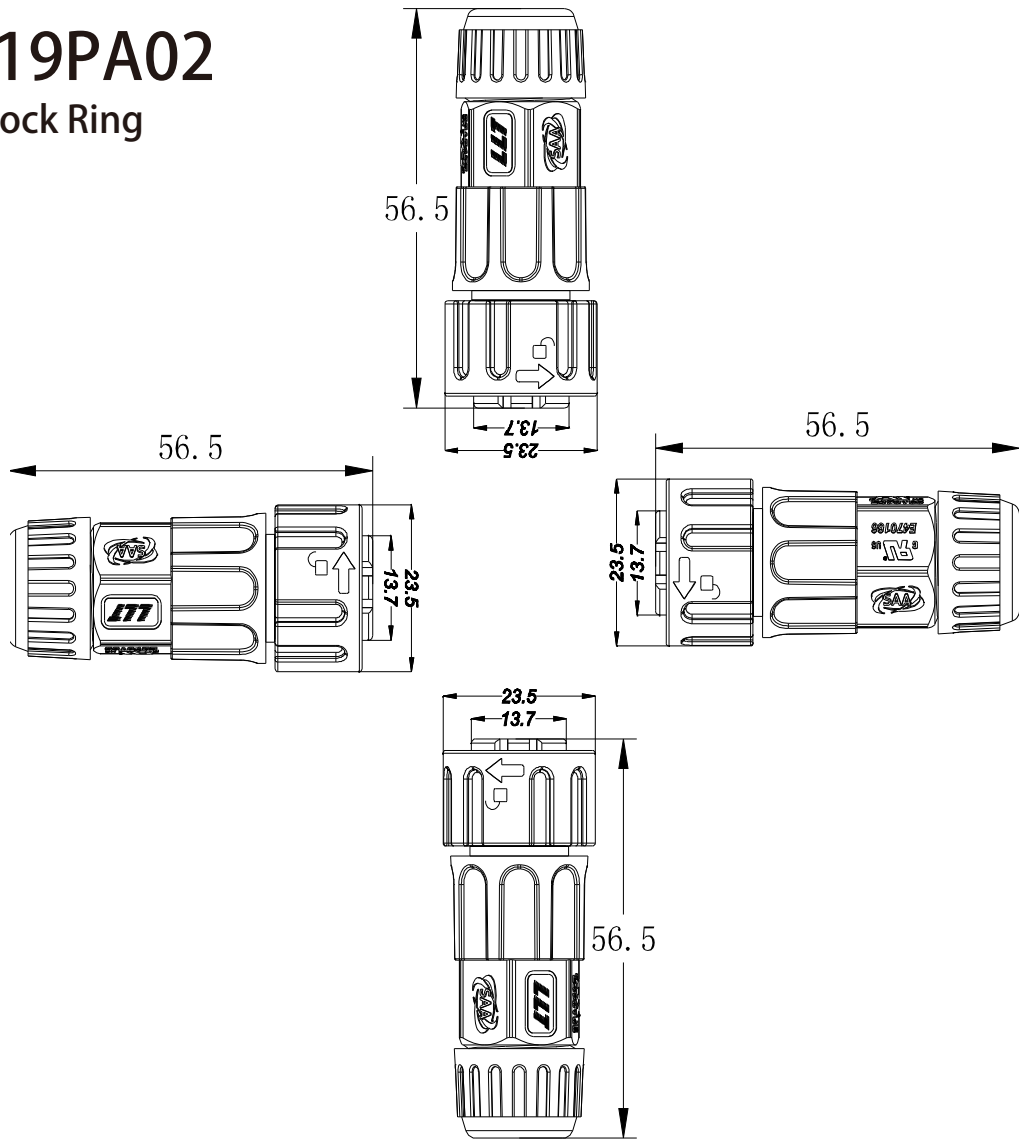

Line
Black
xx AWG
(-)

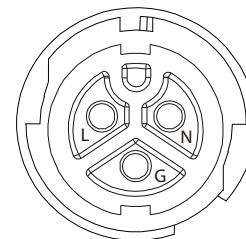

Neutral
White
xx AWG
(+)

Female

Ground
Green
XX AWG

Neutral
White
xx AWG
(+)

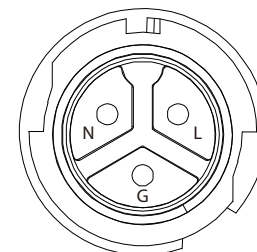

Line
Black
xx AWG
(-)

Male

Ground
Green
XX AWG

SEAPEARL TRADING LIMITED

Part No.	LSP-M19PA02-F-02	LSP-M19PA02-M-02	
Model No.			
Description	Push lock - Black Ring Assembly type Female and Male	Ver.	
		Release Date	2018-7-27
Cable		Draw	曾镇辉
		APP'D	

4

3

2

1

4

3

2

1

Part Number

LSP-M19PM01-F-02 & LSP-M19PM01-M-02

M19PM01

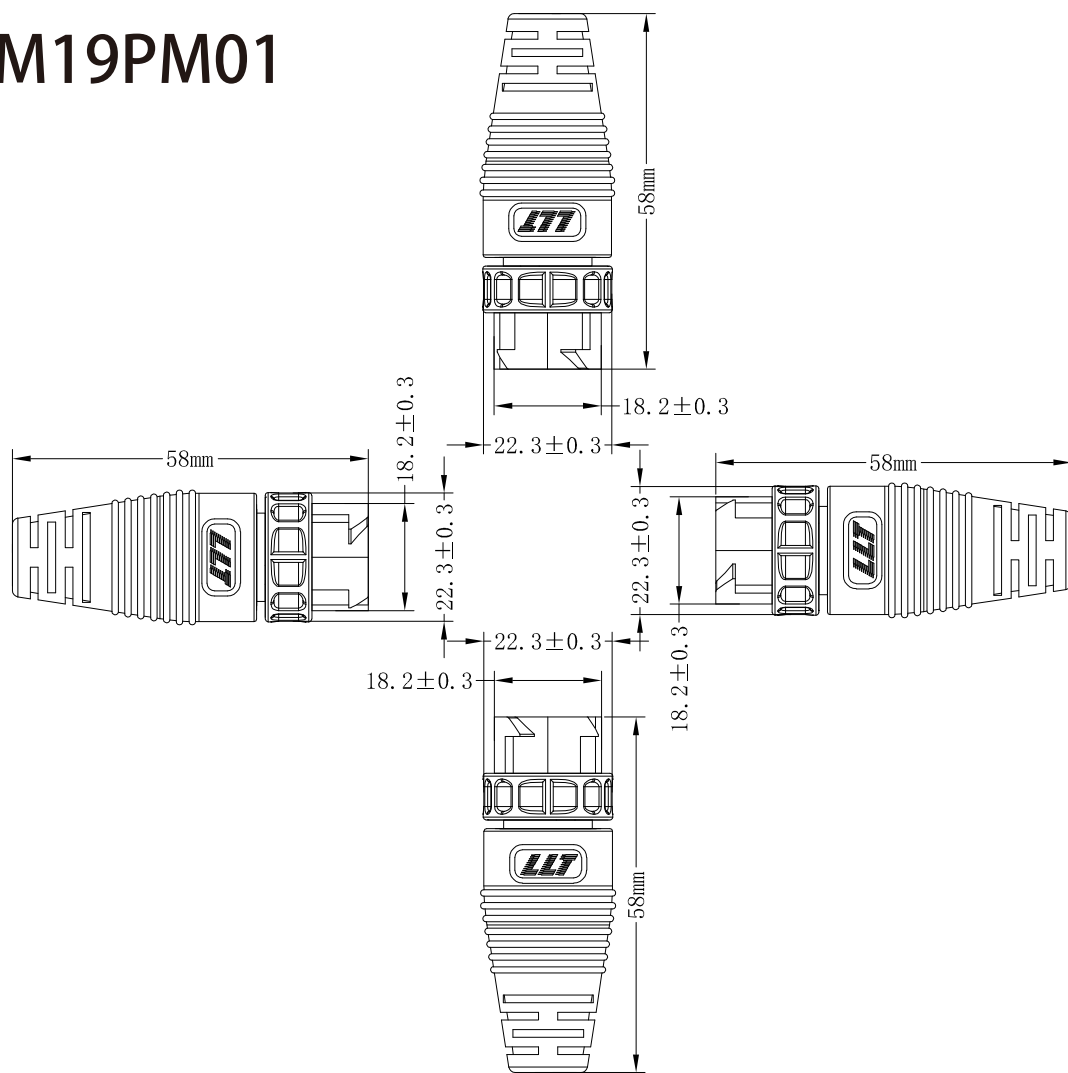

Pin 2
White
VDC (+)

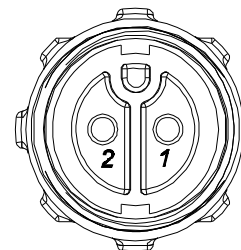

Pin 1
Black
VDC (-)

Female

Pin 1
Black
VDC (-)

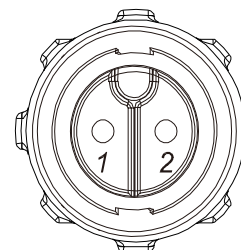

Pin 2
White
VDC (+)

Male

SEAPEARL TRADING LIMITED

Part No.	LSP-M19PM01-F-02	LSP-M19PM01-M-02	
Model No.			
Description	Push lock Molding type Female and Male	Ver.	
		Release Date	2018-7-27
Cable		Draw	曾镇辉
		APP'D	

4

3

2

1

4
Part Number

3
LSP-M19PM02-M-02 & LSP-M19PM02-F-02

2

1

M19PM02
w/Lock Ring

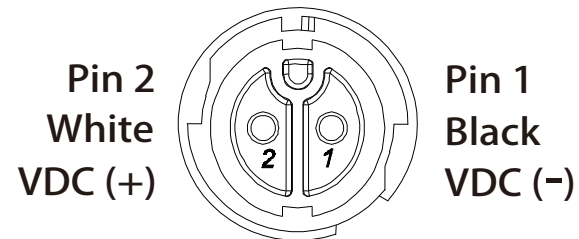

Female

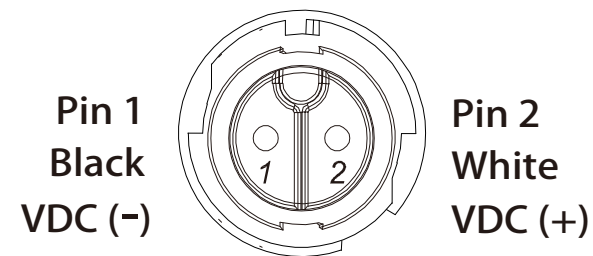

Male

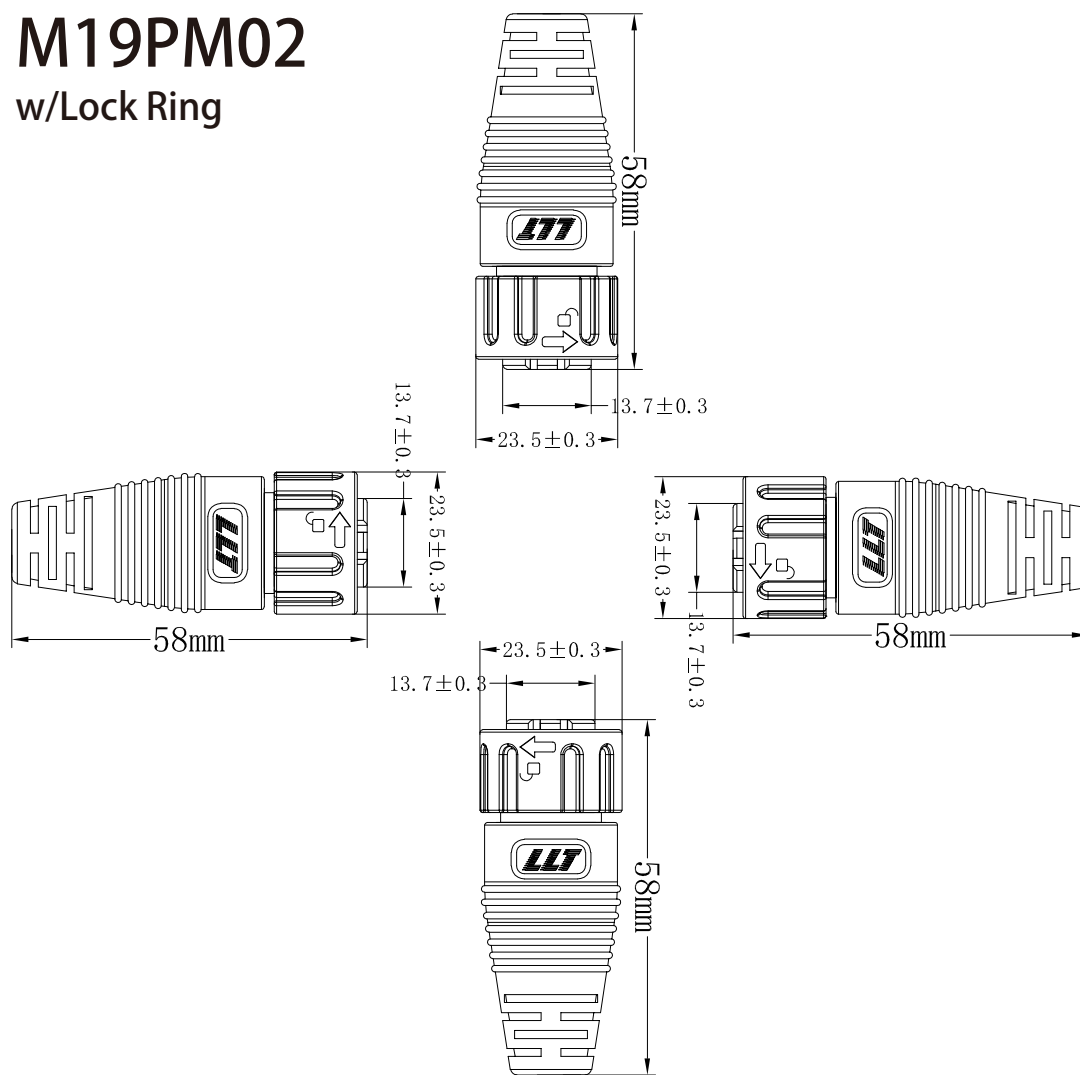

SEAPEARL TRADING LIMITED

Part No.	LSP-M19PM02-F-02	LSP-M19PM02-M-02	
Model No.			
Description	Push lock - Black Ring Molding type Female and Male	Ver.	
		Release Date	2018-7-27
Cable		Draw	曾镇辉
		APP'D	

4

3

2

1

4

3

2

1

Part Number

LSP-M19PM01-F-03 & LSP-M19PM01-M-03

M19PM01

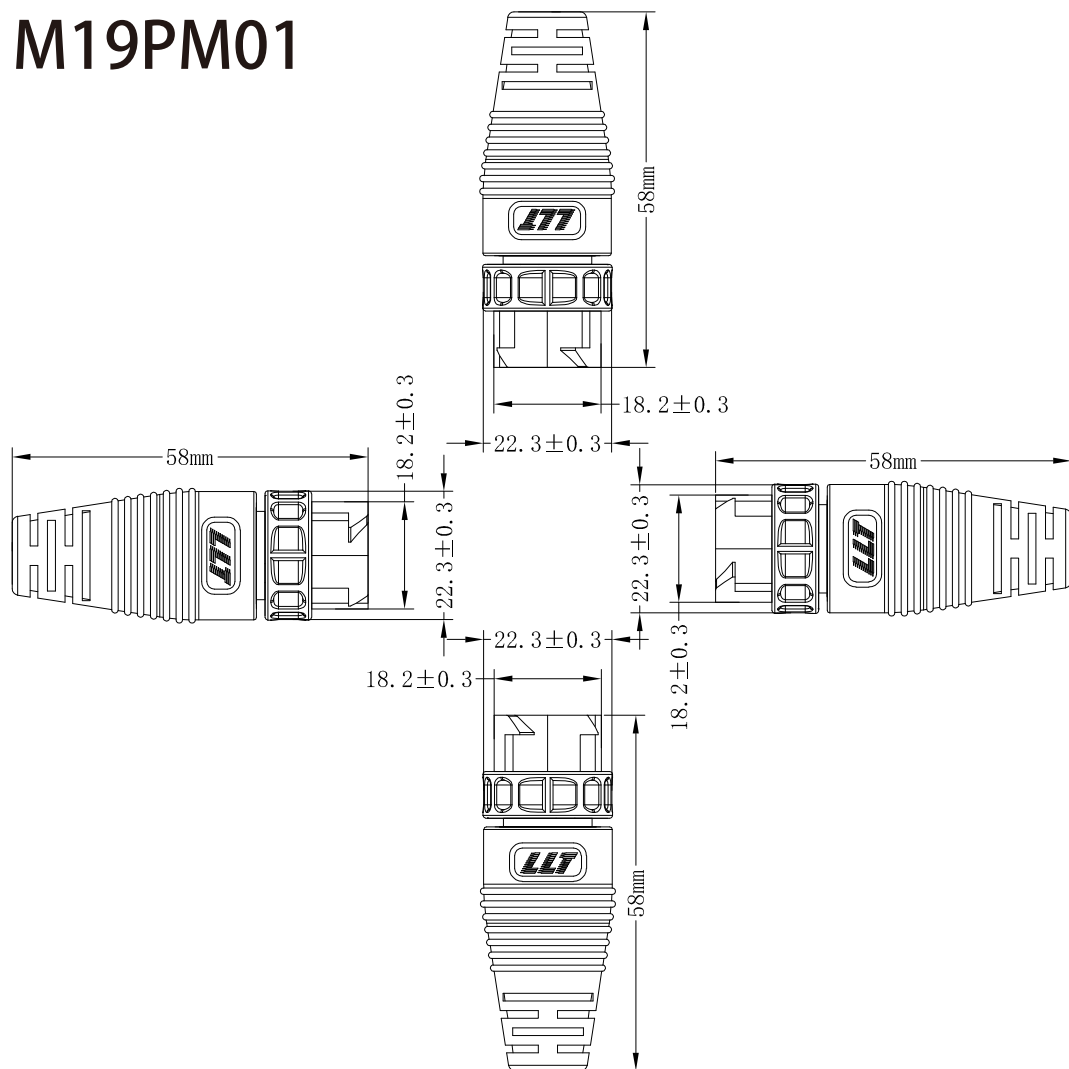
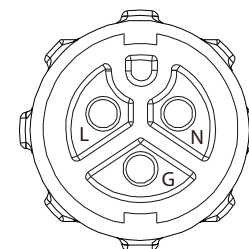
Line
Black
xx AWG
(-)Neutral
White
xx AWG
(+)

Female

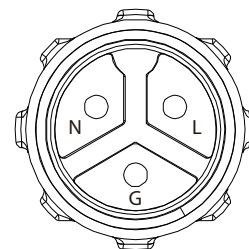
Ground
Green
XX AWGNeutral
White
xx AWG
(+)Line
Black
xx AWG
(-)

Male

Ground
Green
XX AWG

SEAPEARL TRADING LIMITED

Part No.	LSP-M19PM01-F-03	LSP-M19PM01-M-03	
Model No.			
Description	Push lock Molding type Female and Male	Ver.	
		Release Date	2018-7-27
Cable		Draw	曾镇辉
		APP'D	

4

3

2

1

4
Part Number

3
2
1
LSP-M19PM02-M-03 & LSP-M19PM02-F-03

M19PM02
w/ Lock Ring

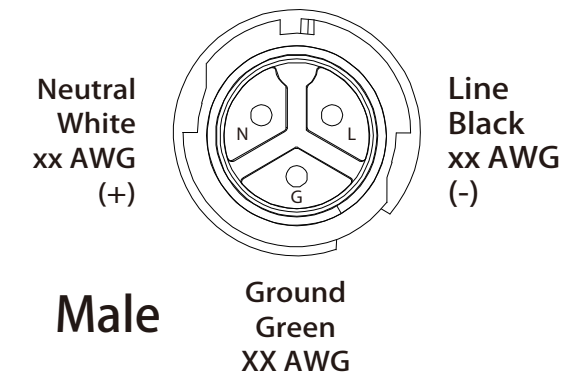
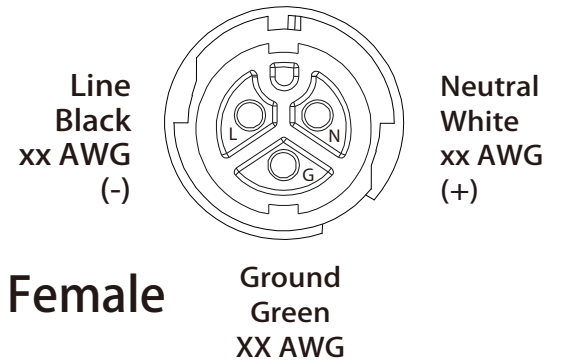
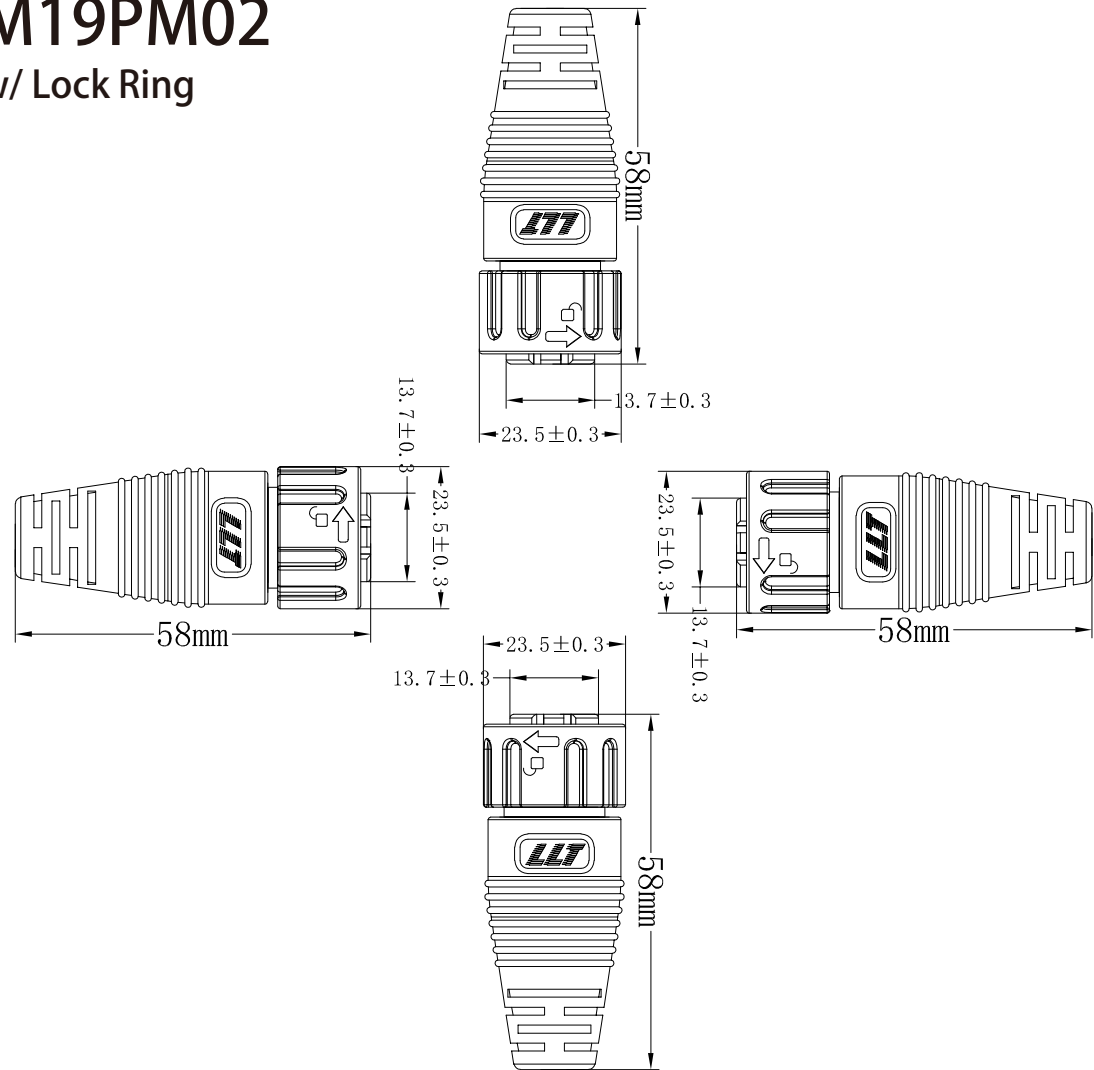

SEAPEARL TRADING LIMITED			
Part No.	LSP-M19PM02-F-02	LSP-M19PM02-M-02	
Model No.			
Description	Push lock - Black Ring Molding type Female and Male	Ver.	
		Release Date	2018-7-27
Cable		Draw	曾镇辉
		APP'D	

4

3

2

1